



Arlington Historic District Commissions

Application for Certificate

(Read attached instructions
before completing form)

For Commission Use Only:
Date Rec: _____
Hearing Date: _____
Certificate #: _____
Monitor: _____

Certificate Requested:

Appropriateness – for work described herein
Minor project Major Project Demolition

Non-Applicability – for the following reason(s):

- Not subject to public view
- Maintenance, repair, or replacement using same design and materials
- Proposed change specifically excluded from review under Bylaw
- Other: _____

Hardship – financial or otherwise and does not conflict substantially with the intent and purposes of the Bylaw

General Information:

Property Address 65 Westminster Ave District Mt. Gilboa
Owner(s) Matthew Quadros & Analise Peleggi Email matt.quadros@gmail.com
Owner's Phone (h) 781-264-4494 (w) _____ (fax) _____
Owner's Address 65 Westminster Ave
Applicant (if not Owner) _____
Applicant's Phone (h) _____ (w) _____ (fax) _____
Applicant's Address _____
Applicant's Relationship to Owner _____

Contractor _____ Phone _____
Architect _____ Phone _____

Dates of Anticipated Work: Start 1/1/23 Completion 2/1/23

Description of Proposed Work: (attach additional pages as necessary) Please include a description of how the proposed work (if a change or addition) is historically and architecturally compatible with the building and the District as a whole.

We are replacing old, failed vinyl windows with replacement vinyl clad wood windows. This house is from 1929 and has non original vinyl windows throughout. We want to replace these with windows that will match the rest of the neighborhood.

Required Documentation Acknowledgement: (see attached instructions)

I acknowledge that I am required to provide supporting documentation, including the attached "Supporting Documents Checklist", by the deadlines indicated in the instructions. I understand that if such documents are not provided in a timely manner, this application will be considered to be incomplete and Commission action may be delayed.

I have read the attached instructions and, to the best of my knowledge, the information contained in this application is accurate and complete. I also give permission for members of the AHDC to access the property for the purpose of reviewing this application and work done under any certificate issued to me.

Owners Signature(s): [Signature] Date: 10/5/22

ARLINGTON HISTORIC DISTRICT APPLICATION

Supporting Documentation Checklist

Property Address 65 Westminster Ave District Mt. Gilboa
 Applicant's Name Matthew Quadros Email matt.quadros@gmail.com
 Applicant's Phone (Day) 781-264-4494 (Mobile) _____

- For Minor Projects or Certificate of Non-Applicability**
- Drawings (11x17 max., with graphic scale, dimensioned, all materials identified) or marked up Photographs (8x10)**
Existing conditions of historic façade(s) to be modified; Show location of proposed work; Show proposed feature(s); Elevations showing proposed work and context; Drawing showing location of proposed work; Drawing showing the proposed feature(s); Site plan for site located equipment and features
 - Manufacturer's literature and specifications sheets describing the proposed feature(s)**
 - Description of how the proposed work is either compatible with the District or Non-Applicable**
- For Major Projects**
- Photographs (8x10)**
Existing conditions of historic structure to be modified (facades, roofs, neighboring buildings); Site; Neighborhood context; Historic precedents for proposed work
 - Drawings (11x17 max., with graphic scale, must show differentiated existing and proposed conditions, dimensions, and all materials identified)**
 - Plans*
Site (showing proposed structures, fences, walls, parking, HVAC equipment, electrical equipment, and relationship to adjacent roads, neighboring buildings); Each floor; Roof (showing valleys, hips, ridges, dormers, skylights, chimneys, vents, HVAC equipment, solar panels)
 - Elevations of building facades- identify:*
Foundation; Siding ; Trim; Gutters; Downspouts; Shutters; Railings; Stairs; Windows; Doors; Roof materials; Roof pitch; Chimneys and vents; Masonry; Light fixtures; Solar panels; HVAC equipment; Electrical equipment; Fences; Signage
 - Wall sections (especially showing projecting features such as bays, balconies, porches, additions)*
 - Relevant exterior detail drawings (architectural trim, eaves, doors, windows, caps, columns, vents, rail systems)*
 - Profile drawings (window and door elements, railings, balusters, stairs, shutters, roof trim, corner boards, casings, water tables, skirts, frieze boards, and all other trim)*
 - For projections, additions and new construction also include:*
Neighborhood lot plan- include footprint to lot area ratio as well as that of neighboring lots; Plot plan- existing building(s), setbacks, proposed new structures; Site section (show relationship to site topography, adjacent structures, major landscape features, roads)
 - Manufacturers' literature and specification sheets describing the proposed components**
 - Suggested Supporting Submittals: Model; Physical Samples**
 - Description of how the proposed work is compatible with the District.**
- For Demolition**
- Statement of current state of existing structure and reason for demolition**
 - Statement of the historic significance of the structure**
 - Site Documentation (including Plot plan; Photographs of existing conditions; List existing materials; Year built; Original architect)**
 - Other provided documentation not described above (please list on a separate attached sheet).**

Applicants Signature(s):  Date: 10/5/22

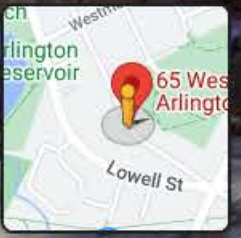



ELEVATE
MARVIN ELEVATE COLLECTION



THE MARVIN PORTFOLIO

The Marvin portfolio consists of five product lines organized into three distinct collections defined by the degree of design detail and customization opportunities.

Marvin windows and doors offer exceptional performance, energy efficiency, low maintenance, and quality you can see, feel, and touch, to help bring your vision to life.



ULTIMATE

Most extensive selection of features, options, and product types



MODERN

Design flexibility in a purely modern aesthetic available exclusively at Marvin Modern dealers



COASTLINE

Custom windows and doors for high velocity hurricane zones in the coastal Southeast



ELEVATE

Wide range of options and product types



ESSENTIAL

Curated options and product types

MARVIN SIGNATURE® COLLECTION

MARVIN ELEVATE® COLLECTION

MARVIN ESSENTIAL™ COLLECTION

INTERIORS	WOOD 6 species options + 2 custom 3 painted or primed options 6 stains + clear coat	EXTRUDED ALUMINUM 5 color options	EXTRUDED ALUMINUM 6 solid colors, 4 woodgrain finishes	WOOD Bare pine, painted Designer Black, Pre-finished White, or clear coat	FIBERGLASS 3 color options
EXTERIORS	EXTRUDED ALUMINUM 19 colors + custom OR WOOD 4 species + custom	FIBERGLASS 5 color options	EXTRUDED ALUMINUM 6 solid colors, 4 woodgrain finishes	FIBERGLASS 6 color options	FIBERGLASS 6 color options
SIZING	Standard + custom sizing for replacement, remodeling, or new construction	Custom sizing for remodeling or new construction	Custom sizing for replacement, remodeling, or new construction	Standard + custom sizing for replacement, remodeling, or new construction	Standard + custom sizing for replacement, remodeling, or new construction
HARDWARE	Extensive selection including Marvin Gallery Hardware	Minimalist hardware for modern design aesthetic	Available in multiple styles, sizes, and finishes to complement the window + door aesthetics	Available in 6 finish options with 2 door handle styles	Available in 6 finish options with 2 door handle styles
COASTAL + WATERFRONT	Hurricane Impact Zones 3 and 4, + PG 50 Products		All products rated for High Velocity Hurricane Zone (IZ4)	Hurricane Impact Zone 3, + PG 50 Products	

Marvin Elevate® collection

THE PERFECT BALANCE OF BEAUTY AND STRENGTH

Balancing beautiful design with superior strength, the Marvin Elevate collection delivers style in any climate. Elevate features warm wood interiors that can blend in or stand out, with Ultrex® fiberglass exteriors for lasting durability. The collection offers a range of carefully selected features and options, making it as versatile as it is elegant.

About Us

At Marvin, we're driven to imagine and create better ways of living, helping people feel happier and healthier inside their homes. We believe that our work isn't just about designing better windows and doors—it's about opening new possibilities for the people who use them.

Casement windows with Simulated Checkrails and Grills-between-the-Glass in Designer Black with Matte Black hardware



Inswing French door with Matte Black hardware

TABLE OF CONTENTS

8	WHY MATERIALS MATTER
10	ENERGY EFFICIENCY
12	DESIGNED WITH PROS IN MIND
14	WINDOWS
16	CASEMENT + AWNING
18	DOUBLE HUNG
20	GLIDER
22	PICTURE
24	BAY + BOW
26	ROUND TOP
20	SPECIALTY SHAPES
30	DOORS
32	SLIDING PATIO DOOR
34	SLIDING FRENCH DOOR
36	INSWING FRENCH DOOR
38	OUTSWING FRENCH DOOR
40	PRODUCT OPTIONS
42	INSTALLATION ACCESSORIES
43	EXTERIOR TRIM
44	DESIGN OPTIONS
46	HARDWARE STYLES
48	WINDOW SAFETY

WHY MATERIALS MATTER

THE MARVIN MATERIALS DIFFERENCE: ULTREX® FIBERGLASS

Choosing the right materials for windows and doors is important when it comes to long-term appearance and performance. Ultrex, an innovative fiberglass material pioneered by Marvin over 25 years ago, was one of the first premium composites on the market. However, not all composites are created equal.

Some companies use materials with fundamentally different properties and performance values to produce a composite material. But Ultrex is different. High density woven fibers bound by a thermally-set resin makes Ultrex more resistant to pressure and temperature than vinyl-based composites. With such different materials grouped in the composites category, it becomes important to know what sets them apart.



TEMPERATURES MAY FLUCTUATE, BUT ULTREX FIBERGLASS WON'T

Ultrex expands and contracts at virtually the same rate as glass so it works with glass rather than against it. This means seals aren't as prone to leaking, and windows aren't subjected to sagging issues like other composites.

This is especially true when compared to vinyl, which can distort in extreme heat and crack in fluctuating temperatures. Ultrex resists distortion even at temperatures up to 285°F. Rapid temperature change doesn't faze Ultrex. From -30°F to 70°F, a 6 foot stile changes less than 1/32 inch in length.

EXPANSION MEASUREMENT

Ultrex expands and contracts at virtually the same rate as glass.

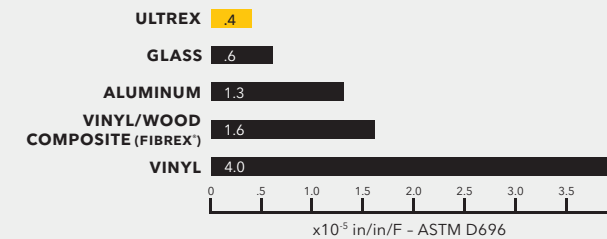

INDUSTRY'S BEST FIBERGLASS FINISH FOR LASTING BEAUTY

Ultrex is the first and only fiberglass finish to be verified to AAMA's 624 voluntary finish specifications for fiber reinforced thermoset profiles (fiberglass).

Windows and doors made with Ultrex resist scratches, dings, and marring more than vinyl. Our proprietary, mechanically bonded acrylic finish is up to three times thicker than painted competitive finishes, and it resists UV degradation up to five times longer than vinyl—even on dark colors.

ACRYLIC CAP

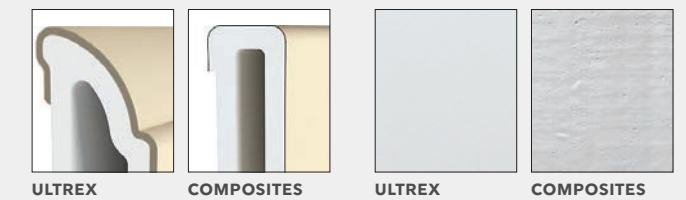

STRENGTH AND STABILITY OF ULTREX

Ultrex pultruded fiberglass has a tensile strength 8x stronger than vinyl and 3x stronger than non-fiberglass vinyl/wood composites. Windows and doors made with Ultrex bend and flex less, resist cracking and separating, and stand up better to everyday wear and tear.

The exceptional strength and stability of Ultrex eases installation and establishes a secure, long-lasting fit that stays square and true, year after year.

RAW FIBERGLASS STRANDS

We start with thin strands of strong glass cables and saturate them with specifically compounded resins.

PULTRUDED FIBERGLASS

We pull the strands through a heated die and cut them with diamond-edged blades to form Ultrex.

PROPRIETARY ACRYLIC FINISH

We then top off our Ultrex fiberglass with a proprietary acrylic finish that is smoother and 3x thicker than other brands.

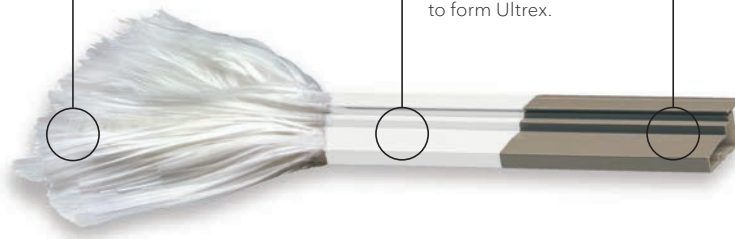

Casement and Direct Glaze windows in Stone White

COOLER IN SUMMER, WARMER IN WINTER

TOP RATED ENERGY EFFICIENCY

The National Fenestration Rating Council (NFRC) defines energy performance ratings for the entire window and door industry. It rates:

- **U-factor:** How well a window keeps heat inside a building.
- **Solar heat gain:** A window's ability to block warming caused by sunlight.
- **Visible light transmittance:** How much light gets through a product.
- **Air leakage:** Heat loss and gain by air infiltration through cracks in the window assembly.

Ultrex® fiberglass is 500 times less conductive than roll-form aluminum and is similar to wood and PVC. It provides an insulated barrier against extreme weather temperatures, keeping homes comfortable, and reducing heating and cooling costs.

ENERGY COST SAVINGS

Marvin was the first major window and door manufacturer to offer energy-efficient Low E2 glass and ENERGY STAR® certified performance on all of our standard windows and doors. Compared to non-certified products, ENERGY STAR certified windows and doors cut heating and cooling costs by 12%.*

The Elevate collection offers Triple-pane, Low E1, Low E2, Low E3, and Low E3/ERS insulated glass with argon gas, which has thermal conductivity 30% lower than that of air. It adds improved solar and thermal protection by distinguishing between visible light, damaging UV, and near-infrared rays to offer the ultimate glass performance. And provides a selection of energy-efficient solutions depending on your climate and needs.

LOW E GLASS COATING

The Low E coating is specially designed to take advantage of the angle of the winter and summer sun. Winter sun is absorbed and conducted indoors. Summer sun is filtered and reflected back outdoors.

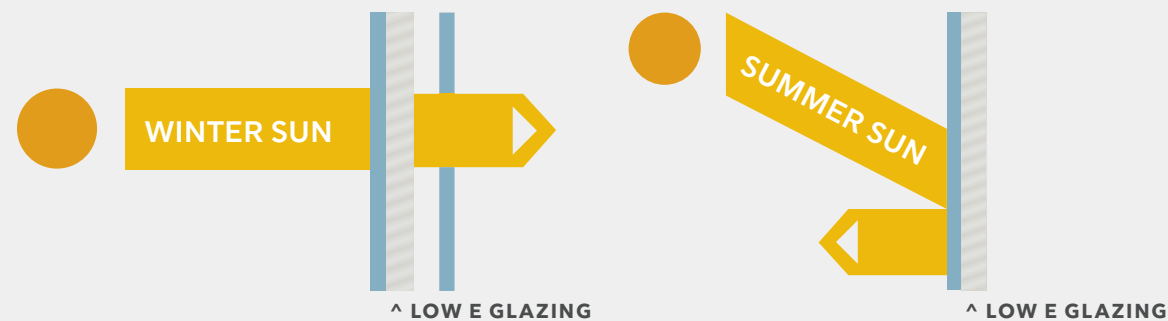

Double Hung window with Sash Lock + Keeper in White

A MORE COMFORTABLE INTERIOR, REGARDLESS OF THE SEASON

Keep heat inside during cooler weather and block the sun's rays during warmer weather with dual-pane windows and Low E coating.

DESIGNED WITH PROS IN MIND

PEACE OF MIND

Every project has its own unique requirements and Marvin is equipped to meet those challenges. Our unique Ultrex® fiberglass construction, available factory services, unmatched delivery, and network of dedicated service and support personnel make the Elevate collection the perfect choice—no matter the project.

EASY TO ORDER, SIMPLE TO INSTALL

The Elevate collection offers simplified options to make the order process straightforward. Installation options and accessories make installing Marvin easier than ever. See page 20 for more information.

MARVIN HAS YOU COVERED

The Elevate collection is backed by a fully transferable 20/10 warranty—20-year coverage on glass, and 10-year coverage on manufacturing materials and workmanship.



Picture and Casement windows in Pebble Gray



MARVIN®

CREATING VALUE AND EFFICIENCY EVERY STEP OF THE WAY

Weather-tight, solid, and durable Ultrex® fiberglass means there are virtually no call-backs. Elevate window and door profiles are optimized for the maximum in performance and fit.

Marvin Elevate® collection
WINDOWS



Casement windows in Bronze

CASEMENT + AWNING



Casement windows with Matte Black hardware



Casement windows with Satin Nickel hardware

CASEMENT + AWNING

- Multi-point sequential locking system provides superior PG50 performance rating with single lever operation.
- Interior screen features an aluminum surround and concealed pressure mounting points for ease of operation and enhanced aesthetics.
- Operating, transom, and picture units available.
- Folding handle neatly stows out of the way. Stainless steel coastal hardware available.
- Casement available in standard and special sizes up to 3 feet wide by 6 feet high.
- Awning available in standard and special sizes up to 4 feet wide by 4 feet high.
- Coordinating Picture and Transom windows also available.
- Narrow frame option with 3 ¼ inch insert replacement frame, flat sill, and through jamb installation.



CASEMENT + AWNING



CASEMENT NARROW FRAME + AWNING NARROW FRAME

 Available with IZ3
(Excludes Narrow Frame option)

DOUBLE HUNG



Double Hung windows in Designer Black with Matte Black hardware



Double Hung windows with White hardware

DOUBLE HUNG

- Equipped with a standard full screen; optional half screen is available.
- Tilt latches are ergonomically designed and easy to operate making tilting and cleaning effortless.
- Sash lock provides a positive detent, reassuring the user that the window is either locked or unlocked.
- Up to PG50 performance rating.
- Equal, Cottage, and Reverse Cottage sash provide a variety of looks and checkrail heights.
- Available in standard and special sizes up to 4 feet 6 inches wide by 7 feet high.
- Coordinating Picture and Transom windows also available.
- Double Hung Insert option features 3/4 inch insert replacement frame with through jamb installation and up to PG40 performance rating.



DOUBLE HUNG



DOUBLE HUNG INSERT



 Available with IZ3
(Excludes Insert option)

GLIDER



Glider window in Prefinished White



Glider window with custom stain finish

GLIDER

- Operating sash easily tilts and removes with no cords or strings to detach.
- Tilt latches are ergonomically designed and easy to operate making tilting and cleaning effortless.
- Available in dual sash with left or right operating panel as well as triple sash with fixed center panel and two operating end panels.
- Innovative screen design for easy installation and removal.
- Up to PG30 performance rating.
- Available in standard and special sizes up to 6 feet wide by 5 feet high for dual sash and 8 feet wide by 5 feet high for triple sash.



INTERIOR



EXTERIOR



SASH LOCK + KEEPER

PICTURE



Picture windows in Pre-finished White



Double Hung and Picture windows in Pre-finished White

PICTURE

- Fixed window available in either in-sash or direct glaze to meet various design needs.
- Both in-sash and direct glaze Picture windows available with IZ3 hurricane rating.
- Direct glaze:
 - › Glass meets the frame directly without a sash for a simple, clean profile with more glass area.
- In-sash:
 - › Designed to match profiles of operable windows in the Elevate collection.
 - › Casement Picture windows available in sizes up to 6 feet wide by 6 feet high.
 - › Double Hung Picture windows available in sizes up to 5 feet wide by 7 feet high.



INTERIOR



EXTERIOR



PICTURE WINDOW PROFILE SHOWN IN BARE PINE



Available with IZ3

BAY + BOW



Casement Bow window

BAY + BOW

- Maximize air circulation with multiple windows.
- Combine Double Hung or Casement windows with a center Picture window.
- Customize with a variety of glass, divided lites, and hardware options.
- Rich Pine interior with a variety of finish options.
- Durable low-maintenance aluminum surround screens.
- Head and seat boards use engineered wood for superior strength, stability, and durability.
- Choose from convenient factory mulling or field mulling kits.
- Bows available in configurations up to 10 feet wide by 6 feet high.
- Bays available in configurations up to 7 feet wide by 6 feet high.



BAY INTERIOR



BAY EXTERIOR

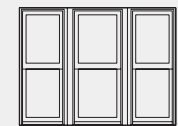

BAY OPERATOR CENTER UNIT



BAY PICTURE CENTER UNIT

Double Hung Bay window

ROUND TOP



Round Top and Casement windows with White hardware



Round Top and Casement windows in Pebble Gray

ROUND TOP

- Extruded aluminum exterior finish.
- Available nailing fin, installation bracket, and through jamb installation.
- Perforated folding radius nailing fin provides for simple installation and proper water management.
- Available factory and field mulling options.
- Standard and special sizes up to 8 feet wide and up to 6 feet high depending on the shape.
- Up to PG50 performance rating.

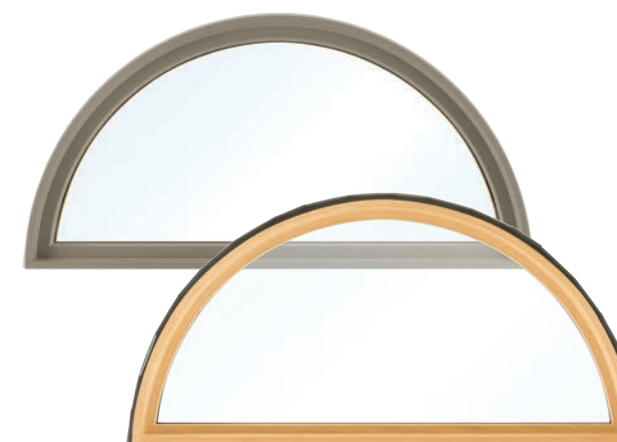

EXTERIOR + INTERIOR

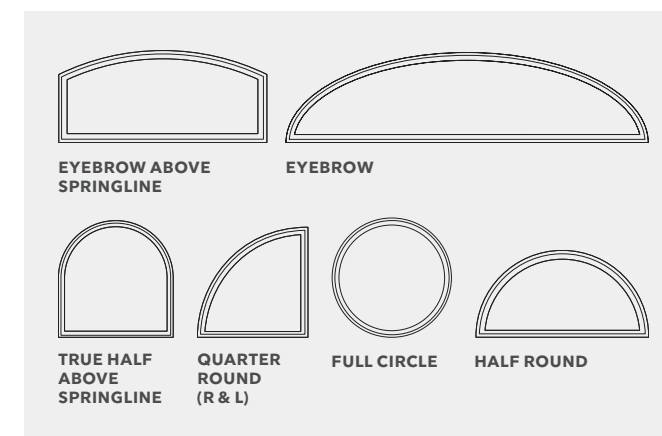

SPECIALTY SHAPES



Specialty Shape windows in Ebony

SPECIALTY SHAPES

- Standard jambs of 4 1/8 inch, 6 1/8 inch, and 6 13/16 inch are available factory applied or as an extension kit.
- Consistent, fast delivery applies to even the most unique products.
- ENERGY STAR® certified and available with Low E1, Low E2, Low E3, and Low E3/ERS insulated glass.
- Up to PG55 performance rating.
- Factory, reinforced, and field mulling kits available.
- Use as sidelights or transoms, or combine for a breathtaking wall of windows.
- Available in sizes up to 49 square feet. Longest leg may not exceed 9 feet.



EXTERIOR PENTAGON



INTERIOR TRAPEZOID

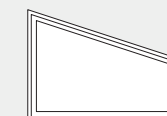
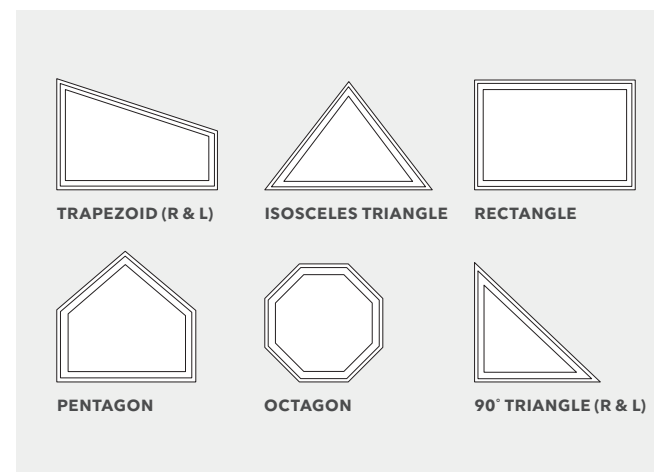

TRAPEZOID (R & L)



ISOSCELES TRIANGLE



RECTANGLE

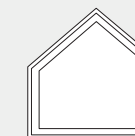

PENTAGON



OCTAGON



90° TRIANGLE (R & L)

Specialty Shape windows in Stone White



Marvin Elevate® collection

DOORS



Inswing French door, Casement, and Picture windows in Ebony

SLIDING PATIO DOOR



Sliding Patio doors and Ultimate Multi-Slide doors in Ebony

SLIDING PATIO DOOR

- Narrow stiles and rails achieve a contemporary styling.
- Low-maintenance Ultrex fiberglass exterior; rich pine interior with a variety of finish options.
- Precision built in special sizes in 1/4 inch increments.
- 2-, 3-, or 4-panel configurations, up to approximately 16 feet wide by 8 feet high.
- Up to PG40 performance rating.
- Top hung screen operates smoothly without jamming.
- Coordinating Transom windows available.
- Bronze or Beige sill available.



INTERIOR



EXTERIOR



CAMBRIDGE HANDLES SHOWN IN SATIN NICKEL

Sliding Patio door in Designer Black

SLIDING FRENCH DOOR



Bi-parting Sliding French door in Stone White with Northfield hardware in Oil Rubbed Bronze

SLIDING FRENCH DOOR

- Wide stile and rail construction showcases the rich wood interior.
- Low-maintenance fiberglass exteriors and rich pine interiors with a variety of finish options.
- Configurations of 2-, 3-, or 4-panels, up to 16 feet wide by 8 feet high.
- Up to PG40 performance rating.
- Optional PG50 performance rating on 2 and 3-panel configurations up to 9 feet wide by 8 feet high.
- Dual ball-bearing rollers for smooth operation.
- Bronze or Beige sill available.



INTERIOR



EXTERIOR



SILL DETAIL SHOWN IN BRONZE

Bi-parting Sliding French door with Northfield hardware in White



INSWING FRENCH DOOR



Inswing French door with Northfield hardware in Matte Black



Inswing French doors in White with custom hardware

INSWING FRENCH DOOR

- Secure and stable stainless steel multi-point locking system.
- Precision built in 1/4 inch increments.
- Available in 1-, 2-, or 3-panel configurations.*
- Multiple configurations up to 6 feet wide by 8 feet high.
- Bronze or Beige sill available.
- PG30 performance rating standard.
- PG50 performance rating optional on 1- and 2-panel configurations.



INTERIOR



EXTERIOR



SILL DETAIL SHOWN IN BRONZE

OUTSWING FRENCH DOOR



Outswing French door with Cambridge hardware in Satin Nickel

OUTSWING FRENCH DOOR

- Low-maintenance fiberglass exteriors and rich pine interiors with a variety of finish options.
- Secure and stable stainless steel multi-point locking system.
- Precision built in 1/4 inch increments.
- Tempered, insulated glass with argon gas.
- Available in 1-, 2-, or 3-panel configuration.*
- Multiple configurations up to 6 feet wide by 8 feet high.
- Bronze or Beige sill available.
- PG50 performance rating standard.



INTERIOR

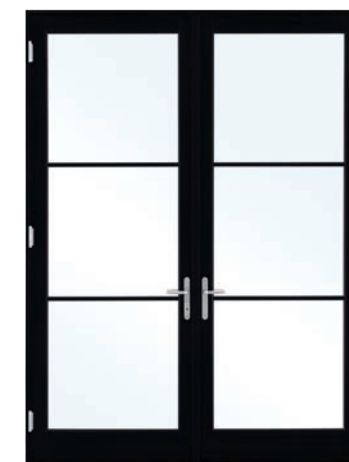

EXTERIOR



DOOR HINGE SHOWN IN SATIN NICKEL

Outswing French door with Cambridge hardware in Matte Black

Photo: Lairy Glenn



Marvin Elevate® collection

PRODUCT OPTIONS



INSTALLATION MADE SIMPLE AND EFFICIENT

INSTALLATION OPTIONS AND ACCESSORIES

1. NAILING FIN

Pre-attached folding nailing fin and drip cap for easier installation.

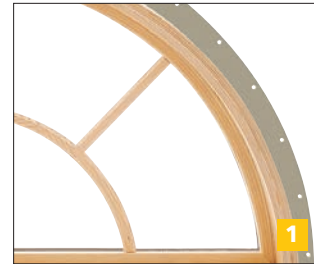

2. THROUGH JAMB

Available through-jamb and installation bracket options.

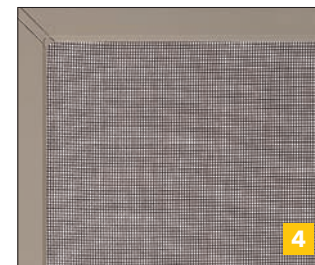

3. FACTORY-APPLIED JAMB EXTENSIONS

Factory-applied jamb extensions save time and labor. We supply 4 7/16", 6 7/16", and 6 13/16" jamb depth in bare wood, white, designer black, or clear interior finish.

4. FACTORY-INSTALLED SCREENS

Factory-installed screens are a standard offering with operating windows. At no extra cost, we can ship your screens separately to reduce on-site damage prior to installation.



5. FACTORY MULLED ASSEMBLIES

Available standard factory mulling, reinforced factory mulling, or field mulling kits. The reinforced mull meets AAMA 450 specifications and performs up to PG50 on standard products and up to PG55 on IZ3 rated products.

6. CORNER KEYS

Integral corner keys keeps window and door units square and corners sealed.



7. CUSTOM SIZES

Custom sizes are available on windows and doors in 1/4" increments for the perfect fit every time.

8. PAINTABLE ULTREX EXTERIOR

The Ultrex® fiberglass exterior is paintable, and holds dark colors better than vinyl or vinyl/wood composites.

EXTERIOR TRIM

Ultrex Exterior Trim is offered with all rectangular Elevate products in all six exterior finishes. The durability, performance, and look of Marvin Elevate windows and doors can be extended to the trim.

BRICK MOULD

2" Brick Mould is available with or without 2 1/8" sill nosing.

FLAT

3 1/2" Flat Trim is available in Flat and Flat Ranch configurations with or without 2 1/8" sill nosing.

SILL NOSE

2 1/8" Sill Nose provides authentic sill appearance.

CONNECTION BARB

Barb and receiver attachment method provides for quick, secure installation.



Casement window with Flat Exterior Trim in Stone White

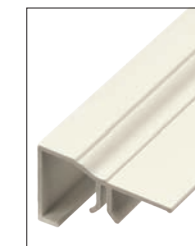

BRICK MOULD



FLAT

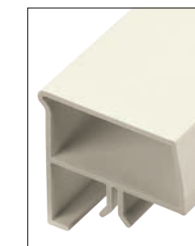

SILL NOSE

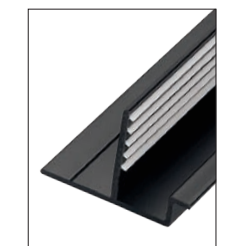

CONNECTION BARB

TRIM CONFIGURATIONS

Multiple configurations are available in lineal lengths and factory pre-cut kits in all six Elevate collection exterior colors.

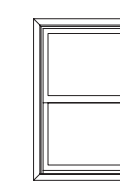

BRICK MOULD

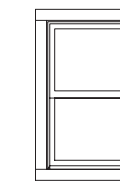

FLAT



FLAT RANCH

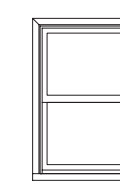

BRICK MOULD WITH SILL NOSE

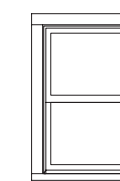

FLAT WITH SILL NOSE

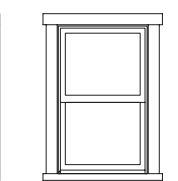

FLAT RANCH WITH SILL NOSE

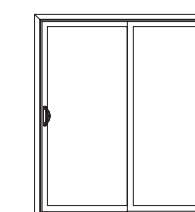

BRICK MOULD*

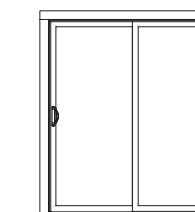

FLAT*

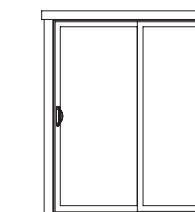

FLAT RANCH*

* Brick Mould, Flat, and Flat Ranch profiles are available on doors. Sill profiles are not included for door trim sets.

DESIGN OPTIONS

INTERIOR AND EXTERIOR FINISHES

Elevate windows and doors features rich pine interiors and a durable, strong, and fully paintable Ultrex® fiberglass exterior, featuring our AAMA-verified acrylic finish for low-maintenance and superior aesthetics. Elevate Round Tops include the extruded aluminum exterior finished in commercial-grade paint for superior resistance to fading and chalking.

WOOD INTERIOR FINISHES

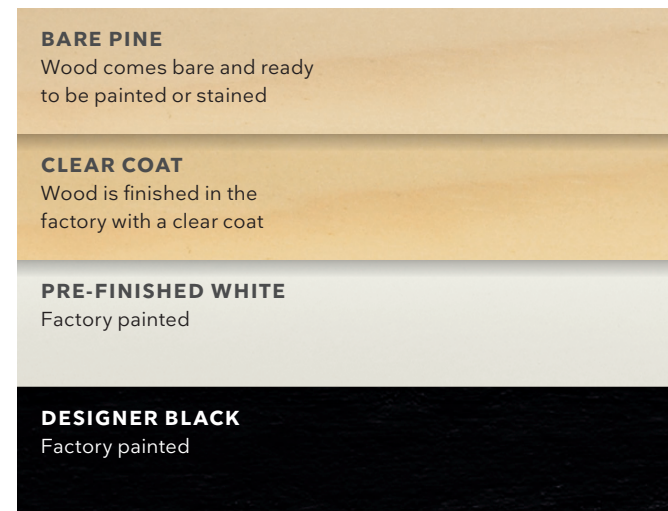

FIBERGLASS EXTERIOR COLORS

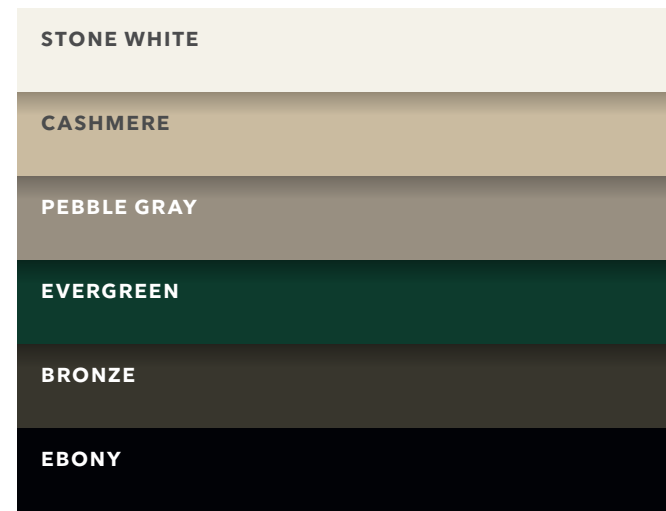

GLASS OPTIONS

Glass is available with Standard Dual Pane or optional Triple Pane on select products. Available with Low E1, Low E2, Low E3, and Low E3/ERS insulated glass with argon gas.* Options include glazing for sound abatement (STC/OITC), high altitudes, and California fire zones. Laminated glass is also offered in products designed specifically for hurricane zones.

DECORATIVE GLASS

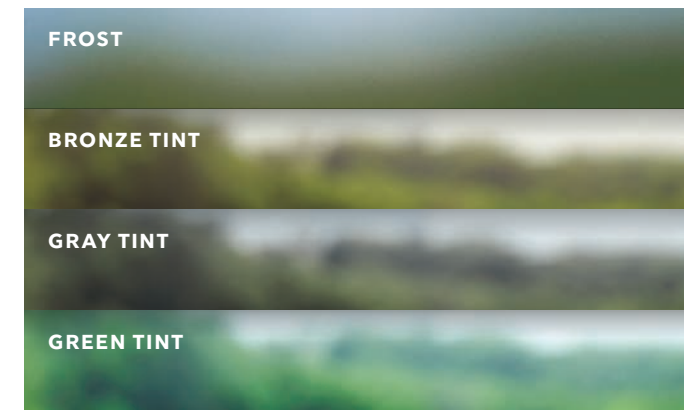
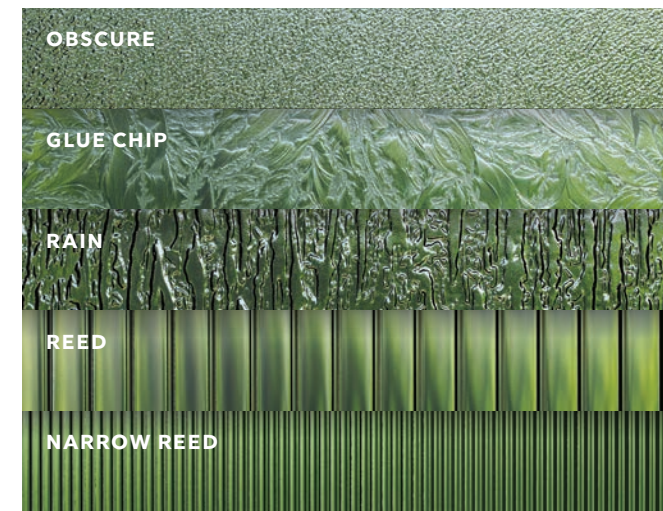

DIVIDED LITES

GRILLES-BETWEEN-THE-GLASS (GBG)

Available in several popular lite cut options for a classic divided lite look and easy glass cleaning. Available in Stone White, Bronze, and Ebony interior and Stone White, Cashmere, Pebble Gray, Evergreen, Bronze, or Ebony exterior.*

SIMULATED DIVIDED LITE (SDL)

Bars permanently adhered to both sides of the glass for a more authentic look. Available with or without spacer bar and in several lite cut options.



GRILLES-BETWEEN-THE-GLASS



SIMULATED DIVIDED LITE

SIMULATED CHECKRAIL

Simulated Checkrail is the perfect solution when aesthetics call for the beauty of a double hung, but operation, egress, or performance demand another solution.

You specify placement of the horizontal simulated checkrail bar and the lite cut patterns above and below.

These illustrations offer a sampling of 7/8" Simulated Divided Lite (SDL) patterns that can be selected in combination with the 2 1/32" Simulated Checkrail on Casement, Awning, Glider, Direct Glaze Rectangle, Picture windows, and all Elevate doors.

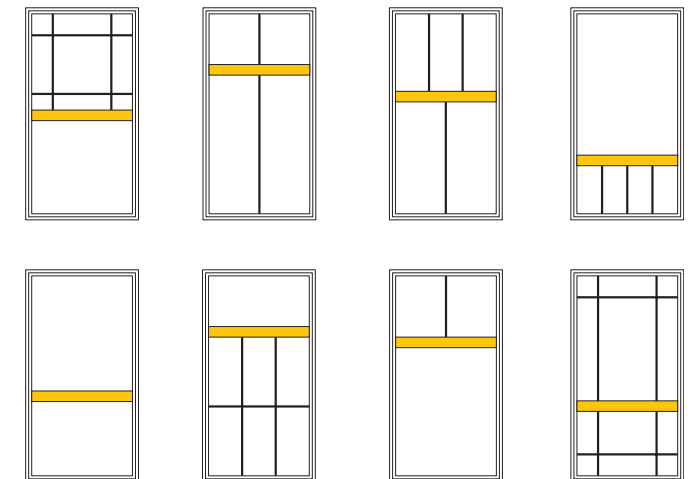

* Not available in polygons except direct glaze rectangles.

* Argon gas not available in high elevations where capillary tubes are required.

HARDWARE STYLES

WINDOW HARDWARE

Windows feature classic low-profile durable hardware for clean aesthetics, safety, and security.



SASH LOCK + KEEPER
Double Hung and Glider



FOLDING HANDLE
Casement and Awning



Double Hung window in Designer Black with Matte Black Sash Lock + Keeper

DOOR HANDLES

Door handles are available in two distinct hardware styles.



CAMBRIDGE



NORTHFIELD

DOOR HANDLE OPTIONS

- Available keyed-alike option (use one key on multiple locks, with up to 3 different keys on each project).
- Choose a distinct interior and exterior handle finish that matches or complements the interior and exterior color of your door.

FINISHES

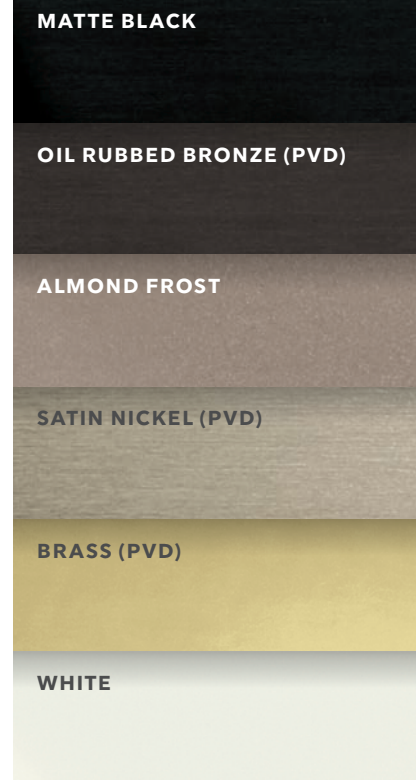

Choose from a variety of hardware finishes to complement your Elevate collection windows and doors.

The Physical Vapor Deposition (PVD) process adds a layer of toughness to hardware exposed to environmental factors like direct sun and humidity. PVD finishes resist fading and discoloration, even in coastal areas. PVD has the highest grade corrosion resistant finish.

PVD finish is available on exterior door hardware in Oil Rubbed Bronze, Satin Nickel, and Brass.



Casement Narrow Frame window with Oil Rubbed Bronze Folding Handle and Lock Lever



Inswing French door with Cambridge Handle in Satin Nickel

SAFE AND SOUND

ACCESSIBILITY OPTIONS

OPENING CONTROL DEVICE

Limits opening to 4", while providing for full egress. ASTM F2090 compliant. Available on Casement, Double Hung, and Glider windows.

SASH LIMITER

Permanently limits sash movement for safety and security.



CASEMENT
OPENING CONTROL DEVICE



DOUBLE HUNG
OPENING CONTROL DEVICE



GLIDER
OPENING CONTROL DEVICE



AWNING
SASH LIMITER

IZ3 PRODUCTS FOR COASTAL LIVING

Our Elevate IZ3 Certified products are specifically designed for the extreme conditions and construction requirements of coastal areas. Rigorously tested by third-party agencies to meet or exceed the most stringent coastal codes, they protect against flying debris, driving rain, cyclic pressure, and extreme temperatures. The Ultrex® fiberglass finish passes AAMA 624 standards for weathering and fading resistance.



Sliding French door and Picture window in Designer Black



IN HARSH COASTAL CONDITIONS,
YOUR WINDOWS AND DOORS MATTER
Marvin offers windows and doors specifically designed for the coast.

THE MARVIN ELEVATE®
COLLECTION IS AN IDEAL BLEND
OF REMARKABLE DESIGN AND
SUPERIOR STRENGTH.

Warm wood interiors add timeless beauty, while resilient, long-lasting Ultrex® fiberglass exteriors stand up to the toughest conditions, outperforming and outlasting vinyl, roll-form aluminum and other composites.



Double Hung and Casement windows in Pebble Gray



Since we opened as a family-owned and -operated lumber and cedar company in 1912, Marvin has designed products to help people live better. We remain committed to bringing beauty and simplicity into people's lives with windows and doors that stand the test of time.

MARVIN.COM

©2022 Marvin Lumber and Cedar Co., LLC. All rights reserved.
®Registered trademark of Marvin Lumber and Cedar Co., LLC.
ENERGY STAR® and the ENERGY STAR certification mark are registered US marks. Printed at Quantum.

Part #19981914. May 2022.

Colors shown in printed materials are simulations and may not precisely duplicate product or finish colors. Contact your local Marvin dealer to view actual product and finish color samples.

[AHDC] Replacement windows for 65 westminster ave

6 messages

matt quadros <matt.quadros@gmail.com>
To: Carol Greeley <carol.greeley@gmail.com>

Wed, Oct 5, 2022 at 11:15 PM



CAUTION: This email originated from outside your organization. Exercise caution when opening attachments or clicking links, especially from unknown senders.

 **IMG-0786.jpg** **Outside house.PNG**

Hello,

I'm writing to request a certificate of non applicability to replace my vinyl windows at 65 Westminster Ave with vinyl clad wood windows. Since the windows being replaced are non original vinyl windows, and the replacements are more appropriate for the home, I'm requesting that this is considered non-applicable work. I've included photos of the outside of the home as well as examples from the inside showing these are vinyl windows. These replacement windows were chosen to maintain the character of the home and match the rest of the neighborhood. I've also included the product specification for these windows.

Matt and Ana

3 attachments **19981914-Marvin-Elevate-Product-Catalog.pdf**
15189K **CCF_000001.pdf**
625K **CCF_000002.pdf**
647K

Carol Greeley <carol.greeley@gmail.com>
To: Beth Cohen <bfcohen@luthcomputer.com>, AHDCChair <AHDCChair@town.arlington.ma.us>

Thu, Oct 6, 2022 at 8:11 AM

Beth,

Steve is out of town for work, do you think this will qualify for a CONA or do I need to put them on the agenda for 10/27? They currently have vinyl windows and want to change to vinyl clad wood windows - thanks for any guidance. I need to advertise now if they are coming in on 10/27. Thanks - Carol

[Quoted text hidden]

--

Carol Greeley, Executive Secretary

Arlington Historic District Commissions

(781) 316-3265

ahdc@town.arlington.ma.uswww.arlingtonhistoricdistrict.com

3 attachments **19981914-Marvin-Elevate-Product-Catalog.pdf**
15189K

 **CCF_000001.pdf**
625K

 **CCF_000002.pdf**
647K

Carol Greeley <carol.greeley@gmail.com>
To: matt quadros <matt.quadros@gmail.com>

Thu, Oct 6, 2022 at 8:12 AM

Received - thanks Matt. I am checking whether it truly qualifies for a CONA or whether you need to come in on 10/27 for a formal hearing to request the change. Will let you know the decision - Carol

[Quoted text hidden]

[Quoted text hidden]

Beth Cohen <bfcohen@luthcomputer.com>
To: Carol Greeley <carol.greeley@gmail.com>, AHDCChair <AHDCChair@town.arlington.ma.us>

Thu, Oct 6, 2022 at 8:38 PM

Well it is a change, but it is slightly better than what they had. I would feel uncomfortable with a CONA, although I would allow it -- IMHO

but I would like the rest of the commissioners to weigh in.

--

[Quoted text hidden]

--

Beth Cohen
Luth Computer Specialists, Inc.
Arlington, MA 02476

bfcohen@luthcomputer.com
Cell 617-721-7256
Twitter: @bfcohen

Carol Greeley <carol.greeley@gmail.com>
To: Beth Cohen <bfcohen@luthcomputer.com>

Thu, Oct 6, 2022 at 8:49 PM

So I will put on for a formal - thanks!
Carol

Sent from my iPhone

On Oct 6, 2022, at 8:39 PM, Beth Cohen <bfcohen@luthcomputer.com> wrote:

[Quoted text hidden]

Carol Greeley <carol.greeley@gmail.com>
To: matt quadros <matt.quadros@gmail.com>

Fri, Oct 7, 2022 at 8:31 AM

Matt,

I spoke with the vice-chair since the chair is out of town, she suggests we have a formal hearing on 10/27 to confirm the windows are acceptable. I will send the legal notice today so we can get you in this month rather than wait until next month (11/17). It is a ZOOM meeting at 8pm on 10/27. Let me know if that's ok for you. - Carol

[Quoted text hidden]